

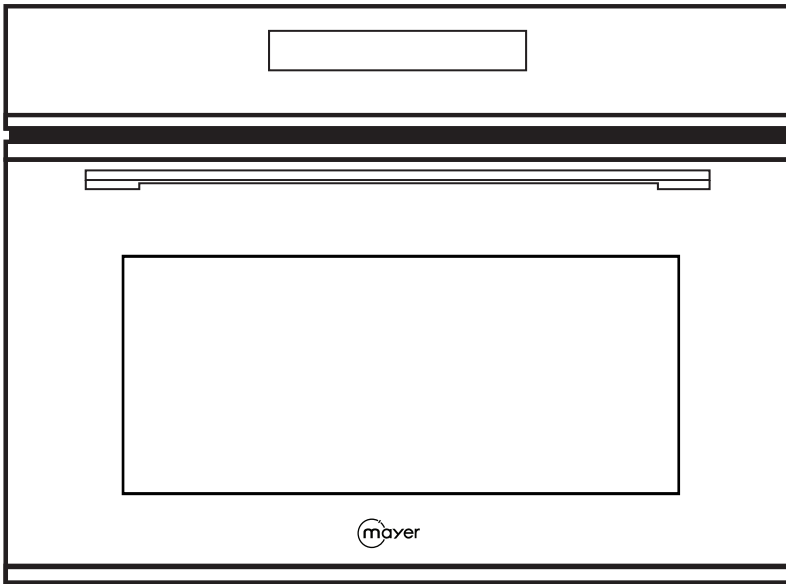

BUILT-IN COMBINATION STEAM OVEN WITH HOT AIR MMSO15-RG



MICROWAVE OVEN

Please read this instruction manual thoroughly before operating and keep it for future reference

CONTENTS

CONTENTS	2
PRECAUTIONS	3
ADDENDUM	3
SPECIFICATIONS	3
IMPORTANT SAFETY INSTRUCTIONS	4-6
TO REDUCE THE RISK OF INJURY TO PERSONS GROUNDING INSTALLATION	7
SETTING UP YOUR OVEN	8
IMPORTANT INFORMATION ABOUT INSTALLING FITTED UNITS	9 10
INSTALLATION DIMENSIONS	10
BUILDING IN	10-11
IMPORTANT INFORMATION BEFORE FIRST USE	11 12
OPERATION INSTRUCTION	13-22
TROUBLESHOOTING	23

PRECAUTIONS

- (a) Do not attempt to operate this oven with the door open. It is important not to break or tamper with the safety interlocks.
- (b) Do not place any object between the oven front face and the door or allow soil or cleaner residue to accumulate on sealing surfaces.

ADDENDUM

If the apparatus is not maintained in a good state of cleanliness, its surface could be degraded and affect the lifespan of the apparatus and lead to a dangerous situation.

Specifications

Model	MMSO15-RG
Rated Voltage	220-240 V~
Frequency	50-60 Hz
Grill	2200 W
Convection	1700 W
Maximum Power	3000 W

IMPORTANT SAFETY INSTRUCTIONS

IMPORTANT SAFETY INSTRUCTIONS WARNING

To reduce the risk of fire, electric shock, injury to persons when using your appliance, follow basic precautions, including the following:

1. Read and follow the specific:"PRECAUTIONS".
2. This appliance can be used by children aged from 8 years and above and persons with reduced physical, sensory or mental capabilities or lack of experience and knowledge if they have been given supervision or instruction concerning use of the appliance in a safe way and understand the hazards involved. Children shall not play with the appliance. Cleaning and user maintenance shall not be made by children unless they are older than 8 and supervised. Children less than 8 years of age shall be kept away unless continuously supervised.
3. Keep the appliance and its cord out of reach of children less than 8 years.
4. If the supply cord is damaged, it must be replaced by the manufacturer, its service agent or similarly qualified persons in order to avoid a hazard.(For appliance with type Y attachment)
5. **WARNING:** Ensure that the appliance is switched off before replacing the lamp to avoid the possibility of electric shock.
6. When heating food in plastic or paper containers, keep an eye on the oven due to the possibility of ignition.
7. **WARNING:** It is hazardous for anyone other than a competent person to carry out any service or repair operation.

8. Only use the temperature probe recommended for this oven. (for ovens provided with a facility to use a temperature-sensing probe.)
9. This appliance is intended to be used in household and similar place .
10. The appliance shall not be cleaned with a steam cleaner.
11. The appliance is intended to be used built-in.
12. Surface of a storage drawer can get hot.
13. **WARNING:** The appliance and its accessible parts become hot during use. Care should be taken to avoid touching heating elements. Children less than 8 years of age shall be kept away unless continuously supervised.
14. **WARNING:** During use the appliance becomes hot. especially inside the cavity. Never touch the interior surfaces of the appliance or the heating elements. Always use oven gloves to remove accessories or ovenware from the cavity, and allow the appliance to cool down. Keep children at a safe distance at the same time to avoid the injury of burns.
15. The appliance must not be installed behind a decorative door in order to avoid overheating. (This is not applicable for appliances with decorative door.)
16. Care should be taken not to displace the turntable when removing containers from the appliance. (For fixed appliances and built-in appliances being used equal or higher than 900mm above the floor and having detachable turntables. But this is not applicable for appliances with horizontal bottom hinged door.)
17. **WARNING:** When move the oven, do not carry handle. (Oven is overweight, handles are easily broken.)

18. The water in the receiving tank, inside the oven and in the water tank should be cleaned up after each use.
19. Do not use the paper cups and plastic containers with temperature resistance below 120 degrees. The glass, ceramic, stainless steel utensils can be used.
20. **WARNING:** When you open the appliance door, hot steam can escape. Steam may not be visible, depending on its temperature. When opening, do not stand too close to the appliance. Open the appliance door carefully. Keep children away. Water in a hot cavity may create hot steam. Never pour water into the hot cavity.
21. **Hazard due to magnetism:** Permanent magnets are used in the control panel or in the control elements. They may affect electronic implants, e.g. heart pacemakers or insulin pumps. Wearers of electronic implants must stay at least 10 cm away from the control panel.
22. Steam is the main heating function for this product.
23. Following operation at high temperatures, only allow the appliance to cool down with the door closed. Do not trap anything in the appliance door. Even if the door is left open a crack. Only leave the appliance to dry with the door open if a lot of moisture was produced while the oven was operating.
24. **Moisture in the cavity:** Over an extended period of time, moisture in the cavity may lead to corrosion. Allow the appliance to dry after use. Do not keep moist food in the closed cavity for extended periods of time. Do not store food in the cavity.

READ CAREFULLY AND KEEP FOR FUTURE REFERENCE

TO REDUCE THE RISK OF INJURY TO PERSONS

Grounding Installation

DANGER

Electric Shock Hazard

Touching some of the internal components can cause serious personal injury or death.

Do not disassemble this appliance.

WARNING

Electric Shock Hazard

Improper use of the grounding can result in electric shock. Do not plug into an outlet until appliance is properly installed and grounded.

This appliance must be grounded. In the event of an electrical short circuit, grounding reduces the risk of electric shock by providing an escape wire for the electric current. This appliance is equipped with a cord having a grounding wire with a grounding plug. The plug must be plugged into an outlet that is properly installed and grounded.

Consult a qualified electrician or serviceman if the grounding instructions are not completely understood or if doubt exists as to whether the appliance is properly grounded. If it is necessary to use an extension cord, use only a 3-wire extension cord.

1. A short power-supply cord is provided to reduce the risks resulting from becoming entangled in or tripping over a longer cord.
2. If a long cord set or extension cord is used:

- 1)The marked electrical rating of the cord set or extension cord should be at least as great as the electrical rating of the appliance.

- 2)The extension cord must be a grounding-type 3-wire cord.

- 3)The long cord should be arranged so that it will not drape over the counter top or tabletop where it can be pulled on by children or tripped over unintentionally. For no plug appliance, means for disconnection must be incorporated in the fixed wiring in accordance with the wiring rules.

Means for disconnection must be incorporated in the fixed wiring in accordance with the wiring rules.

CLEANING

Be sure to unplug the appliance from the power supply.

1. Clean the cavity of the oven after using with a slightly damp cloth.
2. Clean the accessories in the usual way in soapy water.
3. The door frame and seal and neighbouring parts must be cleaned carefully with a damp cloth when they are dirty.
4. Do not use harsh abrasive cleaners or sharp metal scrapers to clean the oven door glass since they can scratch the surface, which may result in shattering of the glass.

SETTING UP YOUR OVEN

Names of Oven Parts and Accessories

Remove the oven and all materials from the carton and oven cavity

Your oven comes with the following accessories:

Instruction Manual 1

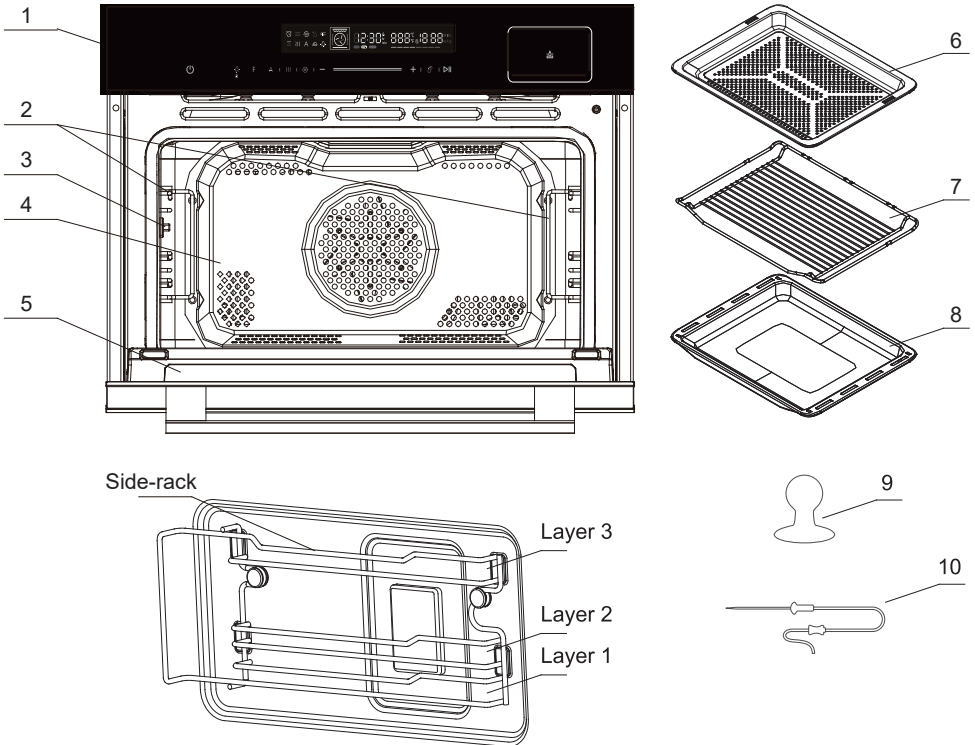

- | | |
|--------------------------|----------------|
| 1. Control panel | 6. Steam tray |
| 2. Side-racks | 7. Rack |
| 3. Meat probe holder | 8. Bake tray |
| 4. Cavity | 9. Sucker |
| 5. Furnace door assembly | 10. Meat probe |

IMPORTANT INFORMATION ABOUT INSTALLING

- This appliance is NOT intended for use in a commercial environment.
- Please observe the installation instructions provided and note that this appliance should only be installed by a qualified technician.
- The appliance is fitted with a plug and must only be connected to a properly installed earthed socket.
- In case a new socket is needed, installation and cable connection must only be done by a qualified electrician. If the plug is no longer accessible following installation, a pole disconnecting device must be present on the installation site with a contact gap of at least 3 mm.
- Adapters, multi-way strips and extension cords must not be used. Overloading can result in fire.
- If the appliance is not fitted with a supply cord and a plug, the connection equipment must have a contact separation in all poles that provide full disconnection, and the appliance must be incorporated in the fixed wiring in accordance with the wiring rules.

The accessible surface
may be hot during
operation.



Fitted units

- This appliance is only intended to be fully fitted in a kitchen.
- This appliance is not designed to be used as a tabletop appliance or inside a cupboard.
- The fitted cabinet must not have a back wall behind the appliance.
- A gap of at least 45 mm must be maintained between the wall and the base or back panel of the unit above.
- The fitted cabinet must have a ventilation opening of 250 cm² on the front. To achieve this, cut back the base panel or fit a ventilation grille.
- Ventilation slots and intakes must not be covered.
- The safe operation of this appliance can only be guaranteed if it has been installed in accordance with these installation instructions.
- The fitter is liable for any damage resulting from incorrect installation.
- The units into which the appliance is fitted must be heat-resistant up to 90 °C.

Installation dimensions

Ventilation openings

behind, min. 250 cm²

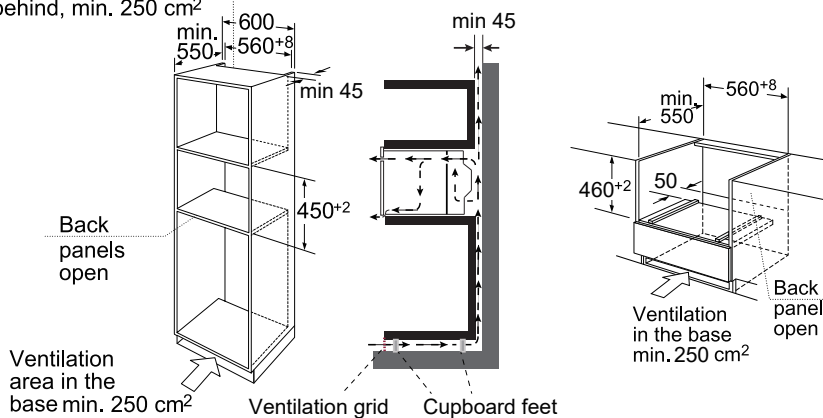

Note: There should be gap above the oven.

Building in

- Do not hold or carry the appliance by the door handle. The door handle cannot hold the weight of the appliance and may break off.
1. Carefully push the oven into the box, making sure that it is in the centre.
 2. Open the door and fasten the oven with the screws that were supplied.

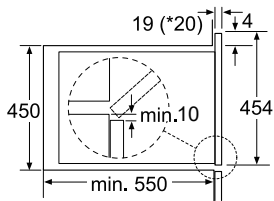
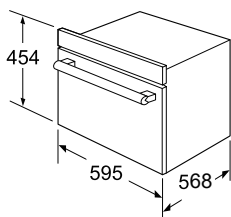

* 20 mm for metal fascias

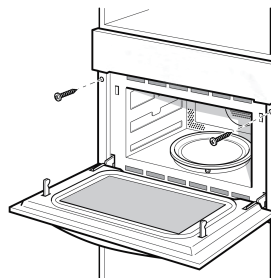

- Fully insert the appliance and centre it.
- Do not kink the connecting cable.
- Screw the appliance into place.
- The gap between the worktop and the appliance must not be closed by additional battens.

Important information

Electrical connection with plug

The appliance is fitted with a plug and must only be connected to a properly installed earthed socket. Only a qualified electrician who takes the appropriate regulations into account may install the socket or replace the connecting cable. If the plug is no longer accessible following installation, an all-pole isolating switch must be present on the installation side with a contact gap of at least 3 mm. Contact protection must be ensured by the installation.

Fuse protection: see instructions for use-technical data.

Electrical connection without plug

The appliance is designed to be permanently installed with a three-pin power cord and may only be connected by a licensed expert in accordance with the connection diagram.

Only a qualified electrician who takes the relevant regulations into account may replace the power cord.

Do not use multiple plugs, power strips or extensions. Overloading causes a risk of fire.

If the connection is no longer accessible following installation, an all-pin isolating switch with a contact gap of at least 3 mm must be provided.

Connect the wires of the mains power cord in accordance with the following colour coding:

Green and yellow Earth wire (E)

Blue Neutral wire (N)

Brown Live (L)

BEFORE FIRST USE

Initial cleaning and heating

Removing the steam oven all of the protection foil on the front.
Before the first use of the appliance:

- Remove all accessories and wash out of the oven.
- Electric heating empty containers. New appliances typically smell when first used. Before using the electrical appliance to cook food faster to heat it helps to banish odors.
- Before heating, it is best to wipe the steam oven interior with a damp cloth. In this way, storage and untwisting appliances accumulated in the packaging process in furnace dust or residual packing material can be removed.
- When the steam oven is electrified, the screen will display "00:00".
- Touch " F " to choose the convection function.
Recommended temperature will be highlighted.
- Raise the temperature to maximum temperature. This can be achieved by using adjustment keys to achieve.
- Touch " ▷|| " key next to the sensor keys. Heat the empty oven for at least an hour.
When you do this, make sure that the room well ventilated. Close the door to the other room to avoid odor pervaded the House.
- Let the appliance cool down to room temperature. Then solution of neutral detergent mixed with hot water to clean inside the steam oven, then wipe dry with a clean soft cloth.
Keep the door open until completely dry in the oven.
Install the side-racks follow these steps.

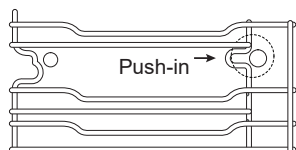

Step 1

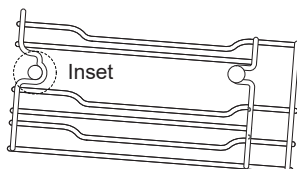

Step 2

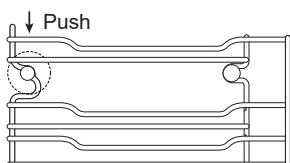







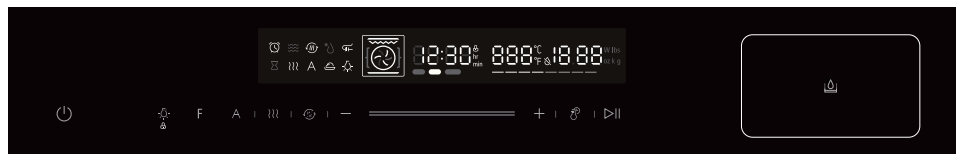

Step 3

OPERATION INSTRUCTION

Control Panel













This steam oven uses modern electronic control to adjust cooking parameters to meet your needs better for cooking.

	ON / Cancel	Switch on steam oven or cancel.
	Lamp ON / OFF	Switch on and off lamp.
F	Oven – Function	Press this symbol to change heating mode.
A	AUTO	Use this to choose auto menu or descaling and cleaning.
	Steam	Steam: Manual adding of steam.
	Quick preheat	Use this to have a quick preheat.
	Slider	Slide it to change the adjustment values shown in the display.
	Duration & Clock Setting Temperature Setting	Set a duration time then select function & set clock in standby mode. Press to set temperature.
	Start / Pause	Start and pause the cooking process.
	Water box	Water box for steam function, the box will pop-up after press it.

" F " Pad instructions

Order	Function	Temperature setting	Time setting
1	 Conventional	50 °C - 230 °C	0:00min - 9:00hr
2	 Convection	50 °C - 250 °C	0:00min - 9:00hr
3	 ECO Convection	150 °C - 200 °C	0:00min - 9:00hr
4	 Conventional + Fan	50 °C - 230 °C	0:00min - 9:00hr
5	 Radiant Heat	100 °C - 235 °C	0:00min - 9:00hr
6	 Double Grill+Fan	100 °C - 250 °C	0:00min - 9:00hr
7	 Double Grill	100 °C - 235 °C	0:00min - 9:00hr
8	 Bottom Heat + Convection	50 °C - 250 °C	0:00min - 9:00hr
9	 Bottom Heat	50 °C - 230 °C	0:00min - 9:00hr
10	 Defrost	/	0:00min - 9:00hr
11	 Fermentation	30 °C - 45 °C	0:00min - 9:00hr
Order	Types of additional function	Temperature setting	Time setting
12	 Meat Probe	50 °C - 100 °C	/







Your steam oven has various operating modes which make your appliance easier to use. To enable you to find the correct type of heating for your dish, we have explained the differences and scopes of application here.

Function	Use
 Conventional	For traditional baking and roasting on one level. Especially suitable for cakes with moist toppings.
 Convection	For baking and roasting on one or more levels. Heat comes from the ring heater surrounding the fan evenly.
 ECO Convection	For energy-saved cooking.
 Conventional + Fan	For baking and roasting on one or more levels. The fan distributes the heat from the heating elements evenly around the cavity.
 Radiant Heat	For grilling small amounts of food and for browning food. Please put the food in the center part under the grill heating element.
 Double Grill+Fan	For grilling flat items and for browning food. The fan distributes the heat evenly around the cavity.
 Double Gril	For grilling flat items and for browning food.
 Bottom Heat + Convection	For pizza and dishes which need a lot of heat from underneath. The bottom heater and ring heater will work.
 Bottom Heat	For add extra browning to the bases of pizzas, pies, and pastries. Heating come from the bottom heater.
 Defrost	For gently defrosting frozen food.
 Fermentation	For making yeast dough and sourdough to prove and culturing yogurt.

Types of additional function	Use
 Meat Probe	For helping baking meat like steak and chicken.







1. Clock Setting





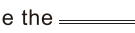

When the steam oven is electrified, "00:00" will display, buzzer will ring once.

- 1) Touch "  " once, the hour figures will flash.
- 2) Touch " — " or "  " or slide the  to set the hour figures. The input time should be within 0--23.
- 3) Touch "  " to confirm, the minute figures will flash.
- 4) Touch " — " or "  " or slide the  to set the minute figures. The input time should be within 0--59.
- 5) Touch "  " to finish clock setting, ":" will flash. The time is set. And the appliance will enter Standby mode.

- Note:
- 1) If you want to change the time, please repeat the step 1 to step 5.
 - 2) If the clock is not set, it would not function when powered.
 - 3) During the process of clock setting, if you press "  " or no operation for 5minutes, the steam oven will go back to the previous status automatically.









2. Functional Cooking Guide

- 1) Touch " **F** " once to activate the Conventional function.
Touch " **F** " repeatedly to select the cooking function you want, the default temperature appeared and the " Conventional ", " Convection ", "ECO Convection", "Conventional + Fan", "Radiant Heat", "Double Grill + Fan", "Double Grill", "Bottom Heat + Convection", "Bottom Heat", "Defrost", " Fermentation" icon will display in order.
- 2) Touch "  " to select the time setting mode.
Touch " — " or "  " or slide  to select the cooking time.
Please refer to table " **F** " **Pad instructions** on page 14 for cooking time setting.
- 3) Touch "  " to confirm the time and enter the temperature setting mode.
Touch " — " or "  " or slide the  to select temperature. Please refer to table " **F** " **Pad instructions** on page 14 for temperature setting.
- 4) Touch "  " key to start cooking.

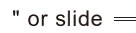



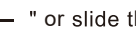

- Note:
- 1) Opening the oven door during operation, operation is suspended. After closing the door, touch the "  " key, operation continues.
 - 2) Cooking time can be changed during operation. Touch "  " key , and then touch " — " or "  " or slide the  to set the cooking time.
 - 3) Cooking temperature can be changed during operation. Touch "  " key repeatedly untill the temperature flashes. Then touch " — " or "  " or slide the  to set the temperature.

Example: if you want to cook with Radiant Heat cooking.

The steps are as following:

- 1) Touch " **F** " five times to activate the function. The default temperature "150" °C will be displayed and the Radiant Heat icon appears.
- 2) Touch "  " to select the time setting mode.
Touch "  " or "  " or slide  to select the cooking time.
- 3) Touch "  " to confirm the time and enter the temperature setting mode.
Touch "  " or "  " or slide the  to select temperature.
The temperature can be selected from 100 to 235 °C.
- 4) Touch "  " key to start cooking.

Change During Cooking



- 1) During the period of appliance operating, you can change the heating type setting and temperature setting by touch " **F** " or slide the  . After the change, if there no other action after 6 seconds the steam oven will heat you changed.
- 2) If you want to change cooking duration time in the cooking process, please touch "  " and slide the  or touch "  /  ". After the change, if there no other action after 6 seconds, the oven will work as you changed. During the cooking process with an end time setting, you can not do any change.
- 3) When you want to cancel the cooking process, please touch "  ".

Note: Changing modes/temperature/rest cooking time may have some negative influences on the result of cooking, we strongly recommend that you do not do this unless you have extensive cooking experience.

3. Quick Preheat

You can use quick preheat to shorten the preheat time. When you select a function, touch the quick preheat symbol "  ", the mark of quick preheat in the screen will light up. If this function can't quick preheat, then buzzer will not ring.

Note:

1. In the process of preheating, pressing the "  " will pause preheating but the preheating function cannot be cancelled.
2. There is no reaction when pressing the "  " during preheating or pause, and the preheating function cannot be cancelled.
3. When the preheating cooking temperature is reached, there will be three beeps, and the preheating icon will go out, and it will directly enter into the working mode, there is no heat preservation stage.
4. Cooking less than 100 degrees, no preheating function.
5. There is no quick preheat in defrost and fermentation.



4. Steam Function

1) In standby mode, press "  " key once, enter the steam mode. The icon is displayed, "100 °C "symbol light.

2) Touch "  " to select the time setting mode.

Touch "  " or "  " or slide  to select the cooking time.

3) Touch "  " to select the temperature setting mode.

Touch "  " or "  " or slide the  to select temperature.

The temperature is from 35 to 100 °C.

4) Touch "  " key to start cooking.

5) The buzzer will sound five times to remind you when cooking is finished , then the oven turns back to standby mode and "End" displays.



Note: the cavity has three shelf positions. Counted from the bottom up. For better cooking effect, Steam tray should be placed on the Side-rack's " layer 2 ".

5. Steam Combi. Function

1) When oven is under standby mode, press "  " key can add steam after mode is set.





2) Steam can be manually add by pressing "  " key during cooking.

3) When oven is under standby mode, press "  " key add steam for cooking. Steam level default setting as level 1.

Notes: Steam has three levels, amount of steam increase with increase of level. press "  " key for once the level will be 1. Press twice will set level 2 and three times for level 3. Whatever level is chosen, light on screen right will show the level (L01/L02/L03). Press "  "key for four times will cancel adding of steam and icon for steam and steam level will off.

Due to vibration caused by transportation, water box may be pop-up status after opening the package. Remember pushing it back.

Steam combi. function contains 3 combined working modes.

Order	Function	Temperatue setting	Time setting	Steam
F (zero)	 Steam	35°C - 100°C Defaulc: 100°C	0:00min - 9:00hr	
F (once)	 Steam+ Convection	160°C - 250°C Defaulc: 160°C	0:00min - 9:00hr	L01:200W
F (twice)	 Steam+Conventional	160°C - 230°C Defaulc: 170°C	0:00min - 9:00hr	
F (thrice)	 Steam+ Double-Grill+Fan	160°C - 250°C Defaulc: 180°C	0:00min - 9:00hr	L03:800W

6. Water Box Function

Steam note:

Press water box and take it out, then take out sealing gasket and add water.

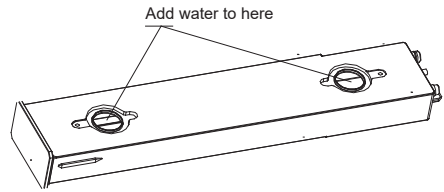
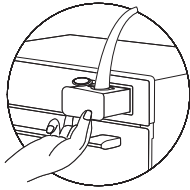

1) Use pure water with a TDS value greater than 3.

2) Before steam cooking:

Before starting the steam cooking mode, if the tank is short of water, press "▷||" key, An abnormal sound reminds you to add water.

Note: Before starting the steam cooking mode, please clean the water tank.

3) During steam cooking:

During steam cooking mode, if the tank is short of water, an abnormal sound reminds you to add water. After adding water, it can work normally.

4) After steam cooking:

1-After steam function is finished, the water in boiler will be withdraw to water tank. This process lasts for about 1 minute.

2-During the process to withdraw the water back to water tank, if the water tank is full, the system will be beeping 10 times to remind you clean up the tank. After the water tank is empty, the system will continue to withdraw water.

Note: After steam cooking, please remove the water from water tank.

If the water box is stuck, suck out the water box with Sucker.

7. Auto Cook

1) In standby mode, touch "A" key once to activate auto menu mode.

2) Touch "—" or "⊕", or slide —————, you can choose different types of cooking menu. (A01 to A16)

3) Touch "▷||" key to start cooking.

Note: 1) Cooking time or temperature can not be set in the Auto Cook.



2) After steam auto menu, the water pump will withdraw the water back to water tank, there will be some noise sound.

3) After steam auto menu, you need to clean the water on cavity and door panel.

4) Some menus include a Preheat function, where the screen displays "Ⓜ" and the timer starts when the preheat temperature is reached. If the menu need preheating, don't put the food in the oven during preheating. Only when the temperature is reached, then put the food in and start cooking. During preheating, the timer won't run until reach the set temperature.

8. Descaling Function

For best cleaning results, we recommend that you use detergent citric acid. Follow the manufacturer's instructions.

- 1) Power up the system, remove the water tank, inject 1000ml of pure water into the water tank, adding a pack of citric acid about (5~10g).
- 2) Push the water tank into the appropriate location of the steam oven.
- 3) In standby mode, touch "  " key for several times until the screen display "A15" which means the oven enters Descaling function. Default time "40:00" lights.
- 4) Touch "  " to start the program.
- 5) When the remained time counts down to 10:00, the program is paused and reminds lack of water. Take out the water tank and pour the water in the tank. Thoroughly clean the water tank.
- 6) Replace the fresh water, Touch "  " to go to.
- 7) when remained time count down to 4: 00 , repeat step 5 and 6.

Note: the descaling process shall not be shut down. If the descaling process shut down before the end, the entire program must be started from step 3.

9. Meat Prob Function

Steam oven has an additional meat probe function. Use a meat probe to detect the temperature inside the meat. Meet probe function has the following five cooking modes.

Cooking mode	Conventional 200°C	Double grill 200°C	Double grill + fan 200°C	Bottom heat +convection 200°C	Radiant heat 200°C
Probe temperature	50-100°C	50-100°C	50-100°C	50-100°C	50-100°C
Default temperature	60°C	60°C	60°C	60°C	60°C

- 1) In standby mode, put the meat probe insert the Meat probe holder. the "  ", " Prob " icon lights.

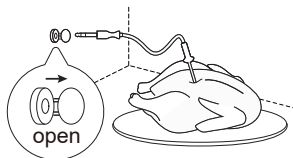

- 2) Put the meat probe insert the Meat, and buzzer will sounds once.(Make sure the head of the probe is placed in center of meat or poultry. Away from fat, bone or hole.)
- 3) Touch " **F** " to choose the fuction, the default temperature setting will display.
- 4) Touch"  " to select the temperature setting mode.

- 5) Touch "— " or " + " or slide "===== " to adjust temperature setting.
- 6) Touch "▷|| " key to start cooking.
- 7) If the core temperature of the food reach the setting temperature of the prob, the buzzer will sound 5 times and the cooking is finished. Pull out the probe, oven will turn back to standby state or clock.

Note: 1) Before start, make sure everything is well prepared.

2) In this mode, you can get the function and temperature setting changed also during the process of cooking.

3)While using a meat probe , please make the head of it into the food instead of some-where else , for the sake of long-term using. Only use the temperature probe recommended for this oven.

4) The cooking time can't be set in the function.

5) Buzzer will sounds once when you insert or pull-out the probe. When it in the setting state and working state, insert or pull-out the meet probe will clean the state.

6) If the probe does not reach the set temperature within 9 hours, the cooking will automatically end. (open and close the door, and the time will not be reset).

7) Please take care of the probe to prevent punctures.

10. Remind Function For Cooking Finish

When finish the cooking time, it will display "End" and buzzer will sounds five times. Press " (I) " or open the door can stop the buzzer and cancel "End", then the oven turns back to the standby mode.

If you don't work any operation for a period of time, the buzzer will sound once and cancel, the oven turns back to the standby mode.

11. Lock-out Function For Children

Lock: In standby mode, press " -⏸- " for 2 seconds, there will be a long "beep" denoting that the lock is activited, and the locked icon will display.

Unlock : In locked mode, press " -⏸- " for 2 seconds, there will be a long "beep" denoting that the lock is released, and the locked icon will disappear.

12. Display Specification

- 1) Touch " (I) " will turn back to standby mode in the setting.
- 2) During setting program, if no other operation, it will confirm automatically after 5 seconds, except for clock setting.
- 3) The steam oven lamp will light if the door is open or oven is paused.
- 4) If door is open during an on-going operation, the operation will be paused.
- 5) " ▷|| " must be pressed to continue cooking if the oven door is open during cooking process.
- 6) The "  " can be press in any state to open the water tank.
- 7) To make the steam oven cools down more quickly after the operation, the cooling fan may continue to run for a period afterwards.

MENU

MENU	DISPLAY	WEIGHT	TIME	POWER	POSITION
Steamed fish	A01	500g	10:00	Steam100°C	Layer 2 of Steam tray
Steamed shrimp with garlic powder	A02	500g	12:00	Steam100°C	Layer 2 of Steam tray
Steamed baby Chinese cabbage	A03	500g	11:30	Steam100°C	Layer 2 of Steam tray
Roast chicken wings	A04	/	20:00	Double Grill220°C+Fan	Layer 2 of Bake tray
Grilled shrimp	A05	/	12:00	Double Grill200°C+Fan	Layer 2 of Bake tray
Seafood bread	A06	/	10:00	Conventional+ Fan 210°C	Layer 2 of Bake tray
Croissant pizza	A07	/	9:30	Conventional+ Fan 180°C	Layer 2 of Bake tray
Cranberry cookies	A08	/	10:00	Conventional+ Fan 180°C	Layer 2 of Bake tray
Roast beef	A09	/	10:00	Double Grilling 235°C	Layer 2 of Bake tray
Sponge cake	A10	/	28:00	Conventional 175°C	Layer 1 of Rack
Cod fish	A11	/	22:00	Conventional+ Fan 200°C	Layer 2 of Rack
Millefoglif of patato yellow and purple	A12	/	30:00	Conventional 180°C	Layer 2 of Rack
Roaster chichen with potatoes novelle	A13	/	45:00	Conventional+ Fan 200°C	Layer 1 of Rack
Roast beff perfect	A14	/	10:00 + 50:00	Double Grilling 230°C + Conventional 120°C	Layer 2 of Rack
Descaling	A15	/	40:00	/	
Clear up	A16	/	5:00	/	

Defect codes

Below defect codes may occur during steam functions :

E-06: 1-Water tank is not close well.

E-05: water system abnormal, need to contact for Engineer to check, below is the possibilities.

- 1-The water sensor is abnormal.
- 2-The water pipe is abnormal.
- 3-The water pump is abnormal.
- 4-The water tank is abnormal.

Note: In the process and at the end of steam function operation, the pump pumping water will produce noise, which is a normal phenomenon.

Trouble shooting

Normal	
Microwave oven interfering TV reception	Radio and TV reception may be interfered when microwave oven operating. It is similar to the interference of small electrical appliances, like mixer, vacuum cleaner, and electric fan. It is normal.
Dim oven light	In low power microwave cooking, oven light may become dim. It is normal.
Steam accumulating on door, hot air out of vents	In cooking, steam may come out of food. Most will get out from vents. But some may accumulate on cool place like oven door. It is normal.
Oven started accidentally with no food in.	It is forbidden to run the unit without any food inside. It is very dangerous.

Trouble	Possible Cause	Remedy
Oven cannot be started.	(1) Power cord is not plugged in tightly.	Unplug. Then plug again after 10 seconds.
	(2) Fuse blowing or circuit breaker works.	Replace fuse or reset circuit breaker (repaired by professional personnel of our company)
	(3) Trouble with outlet.	Test outlet with other electrical appliances.
Oven does not heat.	(4) Door is not closed well.	Close door well.



According to Waste of Electrical and Electronic Equipment (WEEE) directive, WEEE should be separately collected and treated. If at any time in future you need to dispose of this product please do NOT dispose of this product with household waste. Please send this product to WEEE collecting points where available.

