

# mistral

## **Bladefree Fan with Air Purifier MBFAP460**

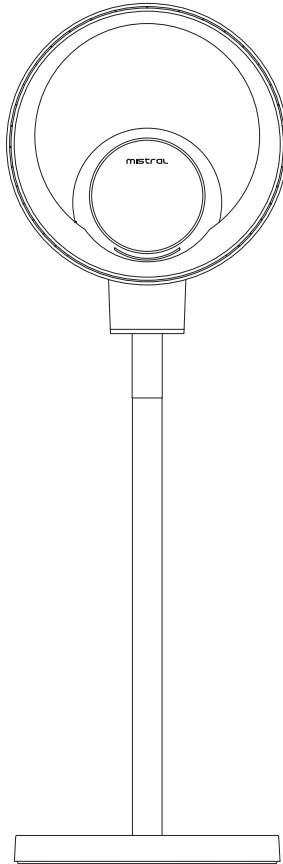

### **BLADELESS FAN WITH AC ADAPTER**

Please read this instruction manual thoroughly before operating and keep it for future reference

# IMPORTANT SAFETY INSTRUCTIONS

## Warning

- This appliance is not intended for use by individuals with reduced physical, sensory, or mental capabilities, or those who lack experience and knowledge unless they have been given supervision or instruction by a person responsible for their safety.
- Children should be supervised at all times while in use.
- Do not use the appliance if the cord or plug is damaged, if the appliance has malfunctioned, or if it has been dropped or damaged in any way. If the power cord is damaged, it should be replaced by the Service Centre to avoid any hazards.
- Always follow basic safety precautions when using electrical appliances to reduce the risk of fire, electric shock, and/or injury.
- Do not immerse the appliance, power cord, or power plug in water or any other liquid.
- Always unplug the appliance from the outlet when not in use and before cleaning.
- Never unplug the appliance by pulling on the cord.
- Only use accessories that come with the appliance, as other accessories may cause fire, electric shock, or injury.

## Bladeless Fan Safety Instructions

- It is recommended to switch off the product, and allow the motor to rest for at least 1 hour after 15 hours of use.
- For your own safety, please clean the product regularly. Accumulation of dust/ pet dander etc. may lead to motor failure or pose a fire hazard. Ensure that the product is switched off when cleaning.
- Do not move the fan when it is connected to the power supply.
- Do not stretch or energize the cable. Keep the cable away from the heat source.
- Do not run the cable under carpets, do not cover it with carpets or any other similar covers.
- Route the cable away from the walking area to avoid tripping over by the power cord.
- Turn off all controls before pulling the plug, and pull the plug out of the socket if you are not going to use the device for a long time.
- Do not place any objects on/cover the air inlet or outlet.
- Make sure that the ventilation openings are free of dust, lint, hair or any other obstacles that could impair the air flow in/out.
- The fan should be set up dry on a horizontal platform and should not be near heat sources, corrosive air and moisture.
- The fan should be kept a distance of 150mm around to ensure good air circulation.
- Do not use the fan outdoors or on a wet surface.
- Please do not use any Air freshener or similar products close to the fan.
- Do not use any cleaning agents or lubricants for this fan.

# PRODUCT TECHNICAL PARAMETERS

MODEL	RATED VOLTAGE	RATED POWER	
MBFAP460	DC24V	35W	
CADR	AIR VOLUME	MAX AIR FLOW	
75-100 m <sup>3</sup>	582 m <sup>3</sup> /min	4.6 m/sec	
MODEL	RATED VOLTAGE	RATED POWER	RATED POWER
AC Adapter	100-240V~ 50/60Hz	24V, 1.5A	36W

# INTRODUCTION OF PARTS

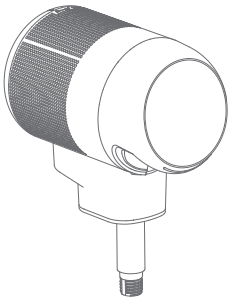

1 Main body of the fan

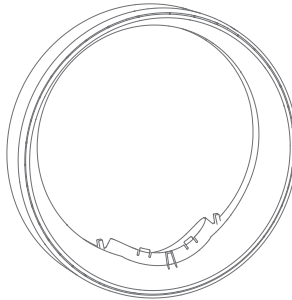

2 Fan air-outlet ring

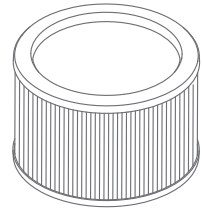

3 The fan air filter



4 Aluminum support of the fan

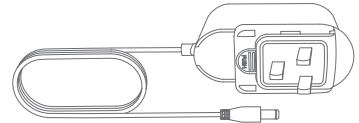

5 The fan power adapter

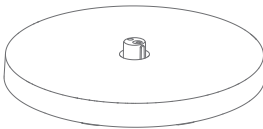

9 The fan base



10 The fan remote control

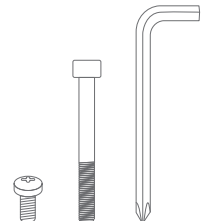

6 The fan air-outlet ring screw x1

7 The fan base bolt x1

8 Wrench x1

LED Control Panel

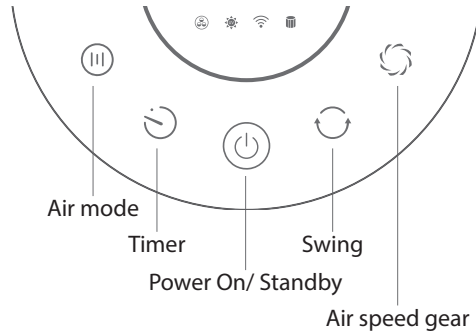

LED Display

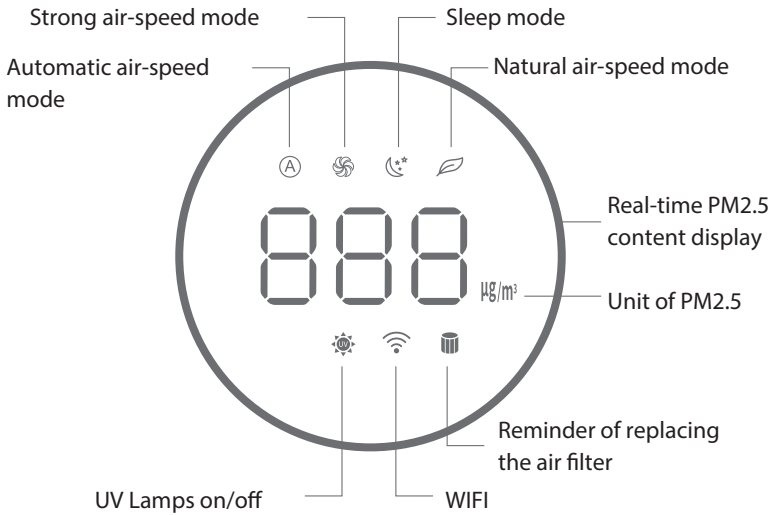

LED Control Panel

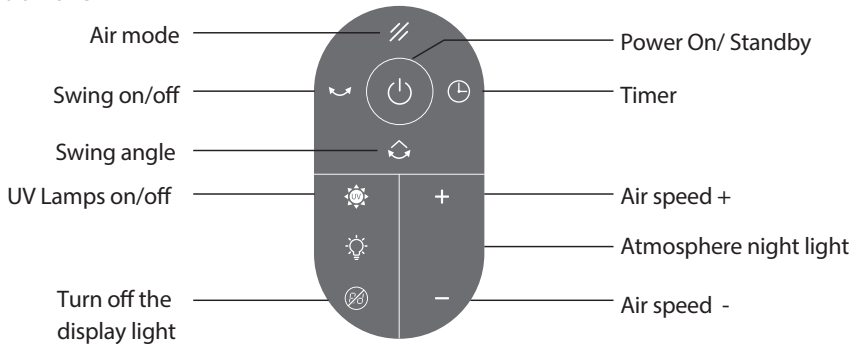

# CONTROLS AND OPERATIONS

## Installation of the bladeless fan

Installing the air outlet ring

1. Install the air-outlet ring to the motor.
2. Insert the fan air-outlet ring screw into the hole at the bottom of the air-outlet ring.
3. Use the wrench to clockwise tighten the fan air-outlet ring screw.

Installing the pillar

1. Insert the aluminum support of the fan into the bottom of the Main body of the fan.
2. Clockwise rotation the aluminum to fixed it with the bottom part of the Main body.

Installing the base

1. Insert the base connecting socket at the lower end of the aluminum support of the fan.
2. Insert the fan base bolt into the hole at the bottom of the base;
3. Tighten the base bolt clockwise by the wrench.

Positioning of the bladeless fan

- Place the fan on a horizontal floor/surface.
- Do not place the fan on any uneven surface/unstable position.
- If there is a slope, please make sure the surface is covered by soft materials to avoid damage or failure caused by tipping over.
- In daily use, it is necessary to avoid any objects blocking the air-inlet. Please keep away from the place with curtains when using to avoid the fan stop working because any object blocks the air inlet.
- Do not place any objects within 30 cm in front of the air outlet to weaken the fan air blowing & air circulating effect.

## Operation

How to operate the bladeless fan

- Connect the power cable to the power port on the base.
- Plug in the adapter to access the power supply, after hearing the "beep", means the fan is connected to the power supply.

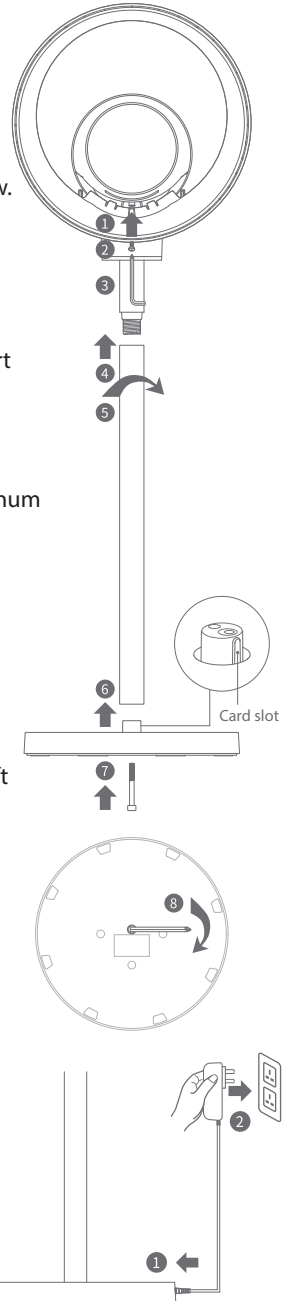

- When the fan is in stand-by state, touch the power button to start the fan running.
- When the fan is in the running state, touch the power button to switch to stand-by state.
- Hold this press for 5 seconds to enter the WIFI connection.

For remote control:

- Press the power button to power ON or standby state. Long press this for 5 seconds to recalculate the air filter working hour.

### Speed

- Touch the speed icon to switch the air-speed gears in turn: 1 - 9 speeds
- Press and hold this for 2 seconds to enter the strong air mode.

For remote control

- Press the speed button to adjust the 1 - 9 speeds.

### Oscillation

- Gently tilt forward/backward on the top part of the air-outlet ring.
- Touch the oscillation icon switch the left and right oscillation.

For remote control

- Press the oscillation button turn on/off the fan swing.
- Press oscillation angle button to switch the left and right oscillation.

Note

- For The left and right oscillation angles, shifts in: 30°, 60°, 90°, 120°, Cancel Oscillation, Repeat. (Using Touch Control Panel)

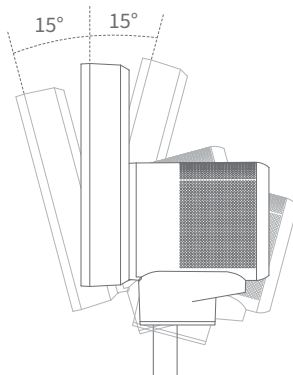

### Timer

- Touch the timer icon to set 1-8 hours timer-off(stand-by state).

For remote control

- Press the timer button to set 1-8 hours timer-off(stand-by state).

Note

- When the power supply is turned off, the former timer setting will be canceled.

## Modes

- Touch the mode icon to switch the modes: Automatic, Strong, Sleep, Natural mode
- The different mode functions:

**Automatic:** Adjusts the speed according to the real-time detected PM2.5 content.

**Strong:** Speed becomes the highest.

**Sleep:** The lowest air speed and noise.

**Natural:** Air volume 3-4-5 gear air-speed in turn.

PM2.5 The numerical	0 - 35	36 - 70	71 - 120	121 - 999
Air speed gear	01	03	05	09
Color of display	green	yellow	orange	red

## For remote control

- Press the mode button to switch the air modes.

## Remote Control

### How to use the remote control

- Please take out the insulating film before the first-time use, as shown in Fig A.

Note: When using the remote control, please point the remote control at the direction of the display screen, as shown in Fig B.

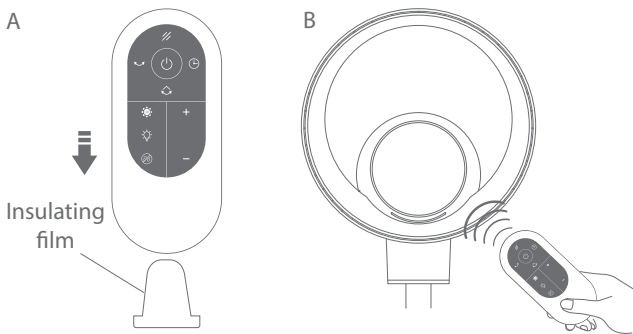

## Remote Control Buttons

- UV Press the UV button to turn on/off the UV lamps, the UV lamps will be off automatically
- after 1 hour.

## Display light

- Press the light button to turn on/off the display screen light.

## Night Light

- Press the night light button to turn on/off the Atmosphere night light.

## Replacing the battery

The operation procedure for replacing the battery of the remote control is as shown in the figures 1-4 as below:

1. Press from the side of the bottom of the remote control to release the battery holder.
2. Pull down and remove the battery holder.
3. When loading the battery, please press the "+" pole face upwards.
4. Install the battery holder back into the remote control.

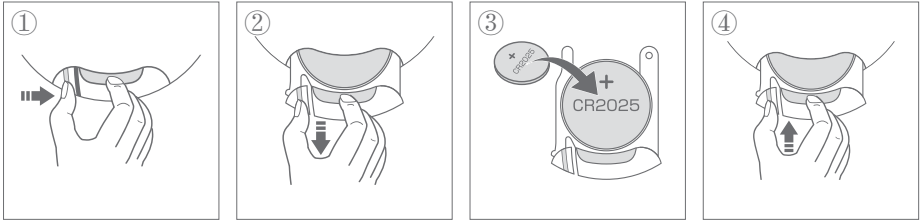

## Warning

- Do not charge the battery! Place it out of the reach of children, do not swallow the battery!
- If the remote control button is invalid, try to replace a new battery;
- When loading the battery, pay attention to the battery orientation, do not reverse;
- Use the remote a distance away from other appliances in order to avoid operation error.
- If not in use for long periods, remove the battery to protect the battery holder.

## Replacement of HEPA filter

1. This product is equipped with a clean air filter(HEPA H13), before using, the HEPA Filter should be installed into the motor filter. It plays the role of purifying air.
2. This product has memory function. After 720 hours of operation, the screen replacement of the HEPA filter indicator light will be on. After replacing the air filter, long press the On/Standby button of the remote control for 5 seconds to extinguish the prompt, and the running time is accumulated again.

## How to install the filter of the bladeless fan

1. Rotate the air filter cover counterclockwise to remove.
2. Put the air filter into the fan main body.
3. The filter cover is loaded into the main body and fixed by clockwise rotation.

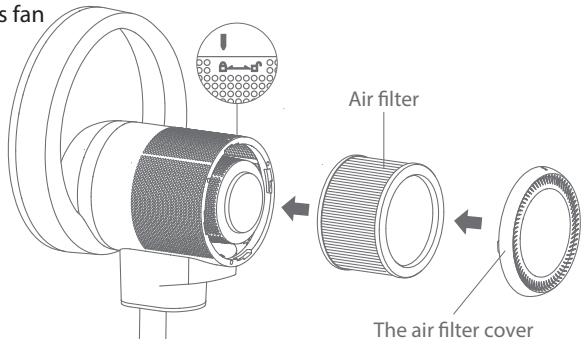

## Wifi

### Application Control Connection

1. Connect your mobile phone to the same WIFI environment with the Fan;
2. Search "Tuya Smart" or "Smart Home" in the APP Store or scan the QR code as below to download and install the APP.



TUYA smart



SMART life

3. Open the APP, register an account and login.
4. The fan stand-by state, long-press the fan control screen on/standby key for 5 seconds, till the WIFI icon start blinking to enter the network pairing mode.
5. On the App Page, click "+" » "Small appliance" » "Fan" at the upper right corner of the APP page to enter the page of adding devices.
6. Check and confirm that the WIFI icon on the fan screen blinks quickly, then click "Confirm that the indicator is blinking quickly" » enter the model connection password (WIFI password) to connect.
7. Check and Confirm that the WIFI icon on the fan screen blinks slowly.
8. On the App Page click "Compatibility Mode" » "Confirm that the indicator blinks slowly" » enter the model connection password (WIFI password) to switch the device hotspot for connection as prompted.
9. The APP displays that it has successfully connected with the Fan.

### Note

- The fan WIFI icon blinks fast/slow, is switched by a long-press on the fan screen on / Stand-by button for 5 seconds.

### To Connect to Google Home

#### Method 1: Use Google Home app to start linking

1. Open the Google Home app and tap + in the top left corner of the homepage.
2. Select Set up device > Works with Google.
3. Tap the Search icon in the top right corner of the page, and search by Tuya Smart / Smart Life app name.
4. Tap the searched result and then Continue. The Google Home app will wake up the Tuya Smart / Smart Life app. Tap Agree and link and wait to the end of loading. This way, the Tuya Smart / Smart Life app is linked with the Google Assistant.

## Method 2: Use Tuya Smart / Smart Life app to start linking

1. If the mobile phone has the Google Home app installed, open the Tuya Smart / Smart Life app and tap Me on the tab bar.
2. In the Third-Party Voice Services section, select Google Assistant > Link with Google Assistant to wake up the Google Home app.
3. Tap Continue to return to the Tuya Smart / Smart Life app
4. Tap Agree and link to access the Google Home app. This way, the Tuya Smart / Smart Life app is linked with the Google Assistant.

For more information on how to connect to Google Home using Tuya Smart/ Smart Life app, Please scan the QR Code or refer to the following link:

<https://developer.tuya.com/en/docs/iot/googlehomeguide?id=K9j6yqpeqzgp>



## To connect to Alexa

Method 1: Operation in the App that needs to be bound (using Smart Life App as an example here)

1. Download the Alexa App and register/login to your Amazon account.
2. Open the App that needs to be bound, go to Home - Me - Third-party Voice Services - Alexa.
3. Click "Sign in With Amazon" and the Alexa App will be launched. Click "LINK" to complete the binding.

## Method 2: Operation in the Alexa App

1. Download the App that needs to be bound and register/login to your account.
2. Open the Alexa App and click "More" in the lower right corner.
3. Click "Skills & Games" and then click the search button in the upper right corner. Enter the name of the skill you need to bind, using Smart Life as an example here.
4. Click the Smart Life skill to enter the skill details page (ENABLE TO USE), click "Agree and link", and return to the Alexa App.
5. Click "CLOSE" and then click "DISCOVER DEVICES" to complete the binding.

For more information on how to connect to Alexa using Tuya Smart/ Smart Life app, Please scan the QR Code or refer to the following link:

[https://support.tuya.com/en/help/\\_detail/K9psi68xxmmg0](https://support.tuya.com/en/help/_detail/K9psi68xxmmg0)



## CLEANING AND MAINTENANCE

- Always unplug the fan from the electrical supply source before cleaning.
- Use a vacuum cleaner with a soft brush attachment to clean the exterior of the fan.
- Be sure to vacuum any dust or dirt that may have accumulated around the base of the fan.
- Wipe the exterior parts of the fan with a soft cloth dampened with mild detergent.
- Keep the vents at the rear of the motor housing free from dust and debris.
- Avoid using any harsh chemicals or abrasive materials that could scratch or damage the fan.
- Do not use gasoline, thinner, or benzene as cleaners.
- Do not attempt to repair it yourself. If service is needed, please contact the Service Centre.

## TROUBLESHOOTING

Problem	Cause of Issue	Solution
The appliance does not power on.	The power cable is not properly plugged in.	Plug in the power supply properly.
The appliance does not power off.	The appliance is faulty.	Please contact the Service Centre for repair.
The remote control does not work.	The battery is flat.	Replace the battery.
	The battery orientation is incorrect.	Reinstall the battery correctly.
	The remote control is not aligned with the receiver on the appliance.	Point the remote controller towards the appliance.