

mistral

18 Inch Floor Fan MFF1845N

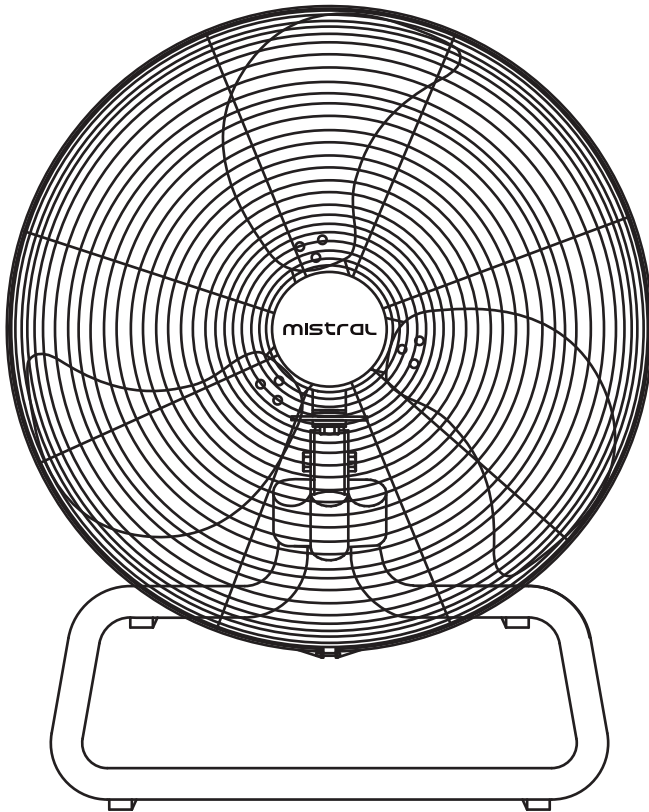

Please read this instruction manual thoroughly before operating and keep it for future reference

IMPORTANT SAFETY INSTRUCTIONS

- This appliance is not intended for use by persons (including children) with reduced physical, sensory or mental capabilities, or lack of experience and knowledge unless they have been given supervision or instruction concerning the use of the appliance by a person responsible for their safety.
- Children should be supervised to ensure that they do not play with the appliance.
- Do not operate any appliance with a damaged cord or plug or after the appliance malfunctions, or has been dropped or damaged in any manner. If the power cord is damaged, it must be replaced by the Service Centre to avoid a hazard.
- When using electrical appliances, basic safety precautions should always be followed to reduce the risk of fire, electric shock, and/or injury.
- Do not immerse appliance, cord or plug in water or other liquid.
- Unplug from the outlet when not in use and before cleaning.
- Do not unplug the appliance by pulling on the cord.
- Use the accessories from the appliance only, as other accessories not from the appliance may cause fire, electric shock or injury.
- This appliance must be earthed.
- Do not insert finger or other objects into the fan guard.
- Do not operate the fan without a fan blade or with a broken/ bent fan blade.
- Do not operate without the grill being properly in place.
- The appliance should be used on a flat, stable, and levelled surface.
- Do not expose the appliance to excessive heat or humidity. This could cause damage to the electrical components.
- Do not cover the cord or place it near heat sources.
- For indoor use only.

PRODUCT TECHNICAL PARAMETERS

MODEL	RATED VOLTAGE	RATED POWER
MFF1845N	220-240V, 50-60Hz	120W
AIR VOLUME		MAX AIR FLOW
94.42 m ³ /min		4.15 m/s

INTRODUCTION OF PARTS

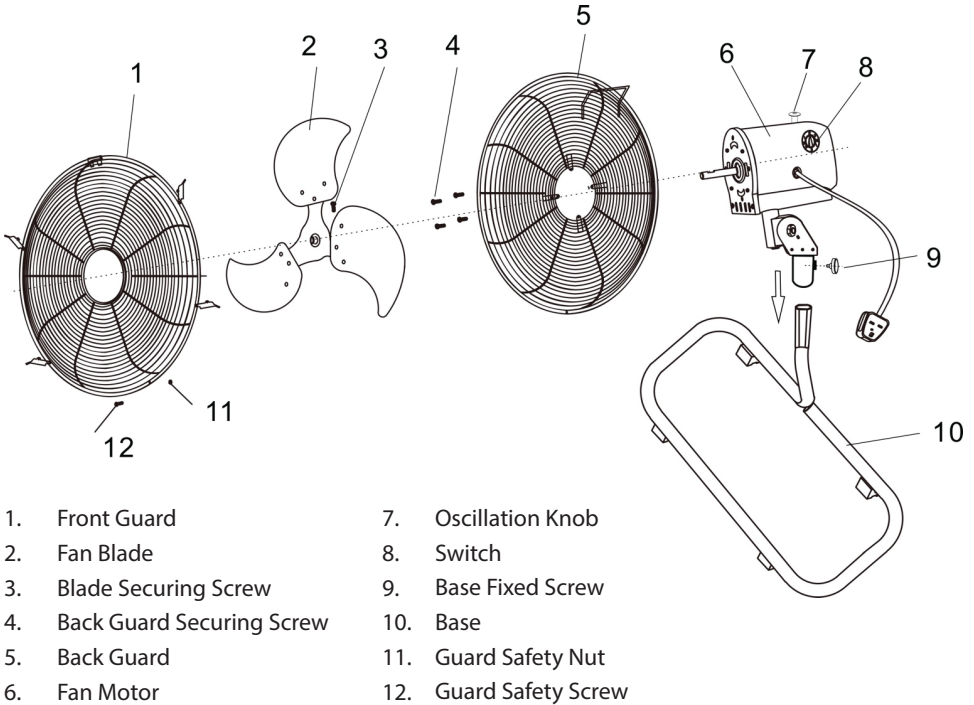

CONTROLS AND OPERATIONS

How to assemble:

1. Slide the Fan motor over the Base and using the Fixed Screw tighten.
2. Remove the 4 screws from the fan motor.
3. Fit the back safety guard into position (with the handle on the back of the guard at the top) and refit the 4 screws and tighten.
4. Slide the fan blade onto the spindle ensuring the screw is lined up with the "flat" surface on the spindle.
5. Push on until the end of the spindle is flush with the end of the fan blade hole, then tighten the screw.
6. Open up all locking clips on the sides of the front guard.
7. Place the safety guard into position by lining up the location plate over the top of the rear guard and push down.
8. Secure the guard by closing the clips over the outer rim.
9. Then using the small nut and screw, fasten the two guards together.

How to use:

Tilting the fan

- Adjust the tilt of the fan head to the desired angle by pushing gently up or down on the fan guard.

Speed

- Turn the speed control knob for the required fan speed.
'0' for 'OFF', '1' for Low Speed, '2' for Intermediate Speed and '3' for High Speed.
The Oscillation Knob is located on the head of the fan. Press the clutch knob down to activate the oscillating function. The fan head will swing from side to side whilst blowing air.
To stop oscillation, allow the Fan head to move into the desired position and then pull the clutch knob up.

CLEANING AND MAINTENANCE

- Ensure that the fan is switched off from the supply mains before removing the guard.
- Turn off and unplug the unit prior to cleaning.
- Clean the motor housing and body assembly with a clean, damp cloth and wipe dry.
- Never spray with liquids or submerge the Fan in water or any other liquid.
- Do not use flammable liquids, chemicals, abrasive creams, steel wool or scouring pads for cleaning.

Storage

- Switch off and unplug the fan. Coil the cable loosely. Do not kink or pull the cable tight.
- Store your fan in a cool, dry location