

# mistral

## 52" Ceiling Fan Typhoon 52

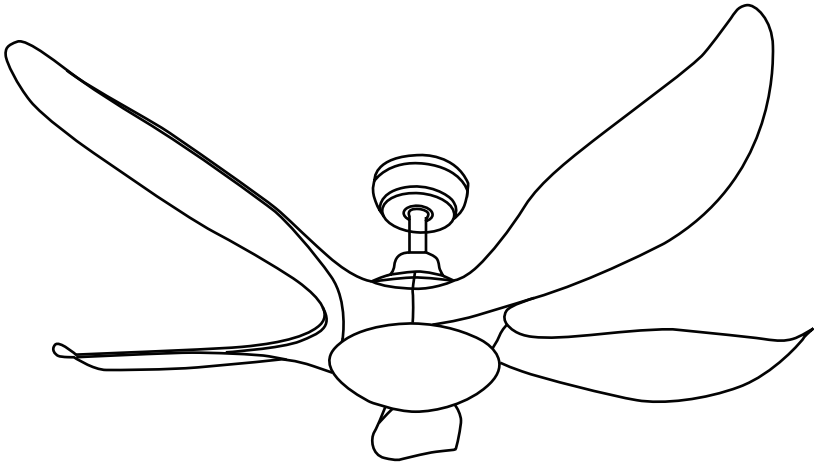

### CEILING FAN

Please read this instruction manual thoroughly before operating and keep it for future reference

# IMPORTANT SAFETY INSTRUCTIONS

## Warning

- This appliance is not intended for use by individuals with reduced physical, sensory, or mental capabilities, or those who lack experience and knowledge unless they have been given supervision or instruction by a person responsible for their safety.
- Children should be supervised at all times while in use.
- Do not use the appliance if the cord or plug is damaged, if the appliance has malfunctioned, or if it has been dropped or damaged in any way. If the power cord is damaged, it should be replaced by the Service Centre to avoid any hazards.
- Always follow basic safety precautions when using electrical appliances to reduce the risk of fire, electric shock, and/or injury.
- Do not immerse the appliance, power cord, or power plug in water or any other liquid.
- Always unplug the appliance from the outlet when not in use and before cleaning.
- Never unplug the appliance by pulling on the cord.
- Only use accessories that come with the appliance, as other accessories may cause fire, electric shock, or injury.

## Ceiling Fan Safety Instructions

- Turn the fan off when not in use, before disassembling, or cleaning. Be sure to fully assemble the fan before switching the power on.
- Do not use any attachments that are not provided by the manufacturer. The fan blades supplied for this fan are matches to minimize wobble. Do not mix the fan blade sets if installing more than one fan.
- Do not attempt to dismantle the fan yourself. Do not separate the reverse switch until the fan has come to a complete stop.
- Do not insert anything into the fan blades while they are rotating.
- To reduce the risk of personal injury, do not bend the blade brackets (also referred to as flanges) during assembly or after installation. Do not insert objects in the path of the blades.
- Avoid fixing inside a dome ceiling.
- According to safety regulations, please follow all the explanations below:
  - The lowest point of the fan blade must be mounted above 2.3m from the floor.
  - For the fan installed enclosed outdoors, the fan must be installed at least 1.5m from the perimeter of roof/eaves of the enclosure to protect the appliance from direct or indirect rain water or sunlight.

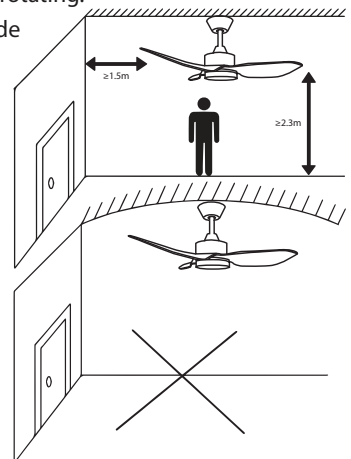

# PRODUCT TECHNICAL PARAMETERS

MODEL	RATED VOLTAGE	RATED POWER
TYPHOON 52	220V-240V, 50/60Hz	69W (DC Fan: 45W   Light: 24W)

# INTRODUCTION OF PARTS

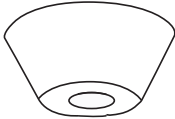

Upper Canopy

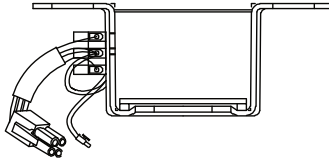

Mounting Plate

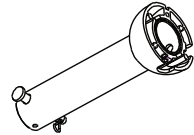

Support Rod

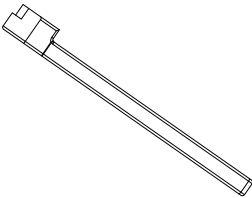

Blades x3

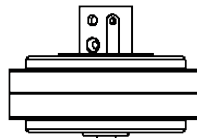

Motor

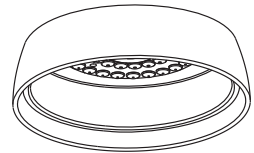

LED Light Kit

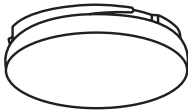

Lamp Shade

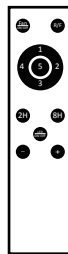

Remote Control

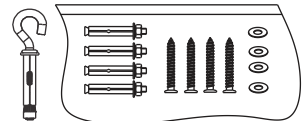

4x Screws & washers  
4x Expansion screws  
4x Expansion bolts  
1x J Hook

# CONTROLS AND OPERATIONS

## WARNING

- To avoid injuries or damages, be sure to turn off the power to the fuse box before wiring.
- Connect the electrical wiring according to the Diagram F below:

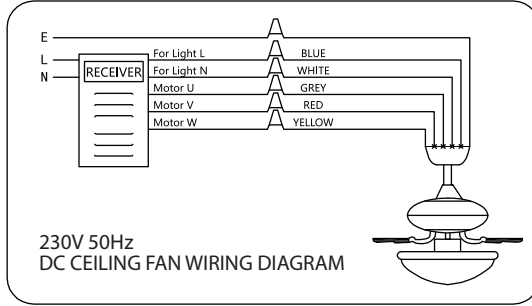

## Receiver place

### WARNING

- Turn off the main switch at the DB (Electrical distribution box).

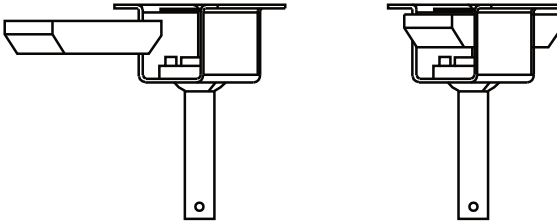

## How to install

### Assemble the suspension system

1. Assemble the suspender, upper cover and lower cover.
2. Connect the assembled parts to the motor and fix the screw and R pins.

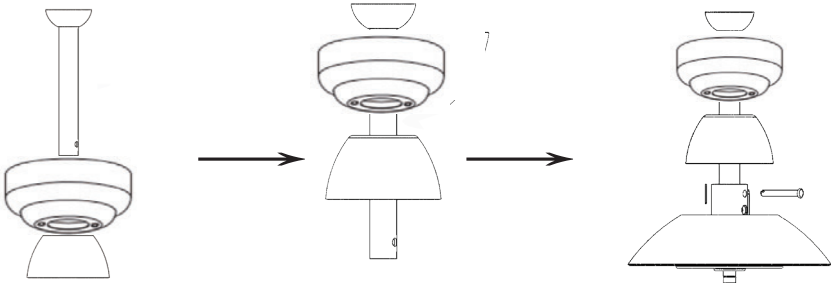

Drawings Showing Acceptable and Not Acceptable Fan Motor Shaft for Decorative Ceiling Fan

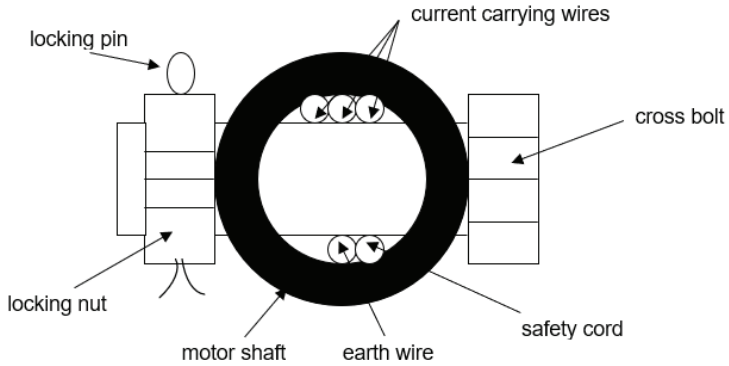

**Figure A: Not Acceptable (wires under stress)**

Please note that when safety wires go through the motor shaft, it needs to be in sleeve under CPS Requirement.

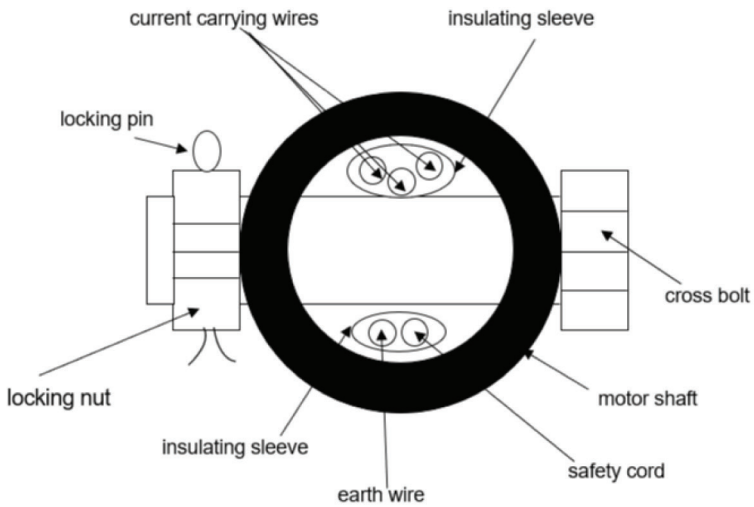

**Figure B: Acceptable (wires not under stress)**

Fan blade installation

1. Take out the corresponding screw on the motor.
2. Point the fan blade at the corresponding hole on the motor, and tighten it with the removed screw.

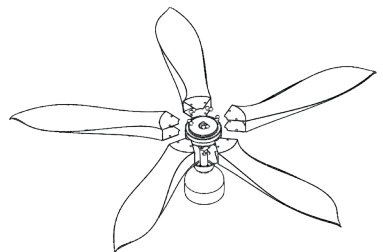

## Installation of LED

1. Align the lamp plate with the screw hole and lock it with the screw.
2. Put in the LED lamp, connect the power cord, and fasten the lamp cover.

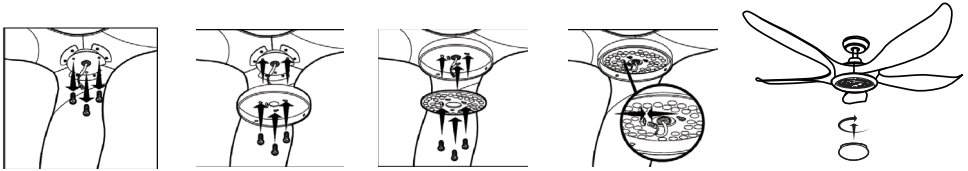

## Mounting Bracket Installation

1. Use expansion Bolt to fix mounting plate and J hook on the ceiling, and also use the nut to lock tightly.

WARNING:

- COTTER PIN MUST BE INSERTED TO PREVENT THE NUT FROM LOOSENING!
2. Hanging up the Ceiling Fan and secure the ceiling fan onto the plate.

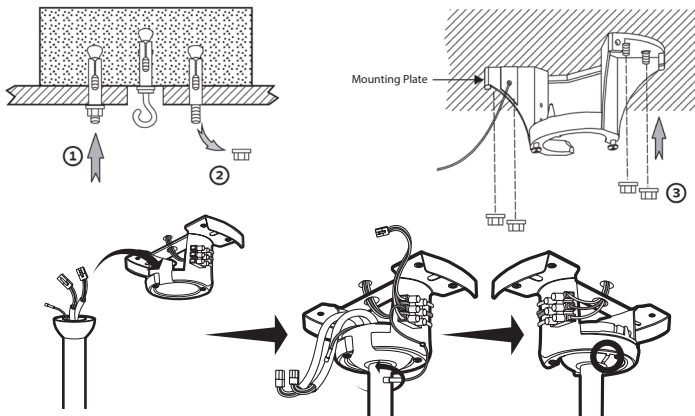

## Diagram Showing the 3 Expansion Bolts, Safety Cord, Expansion Bolts with Hook and Mounting Plate of Ceiling Fan

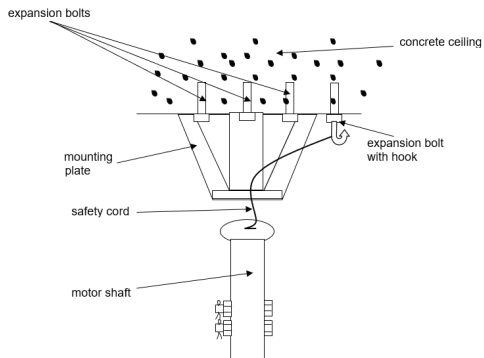

### Install the top canopy

1. Align the hole of the canopy with the screw on the hanger.
2. Fasten it to the hanger and turn it counterclockwise to lock the screw.

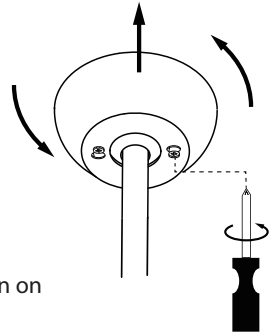

### Remote Control

1. Turn on the ceiling fan,
2. Within the first 20 secs continue pressing the button with the fan on and off until you hear a beep sounds.
3. If there is no beep sound, turn off the ceiling fan and try step 1 and 2 again.
4. Press the "Fan ON/OFF" button to switch on and off the fan.
5. Press the numbers button to adjust the speed from 1 - 5.
6. Press the "R/F" button to change the fan's direction, forward or backwards. (This function as to circulate the air without feeling the wind.)
7. Press the "2H" or "8H" button to adjust between 2 - 8 hours for the automatic fan and light to stop. The timer will count from the last selected time.
8. Press the "LED ON/OFF" button to control the light switch.
9. Press the "+" and "-" to adjust the brightness of the LED lights.

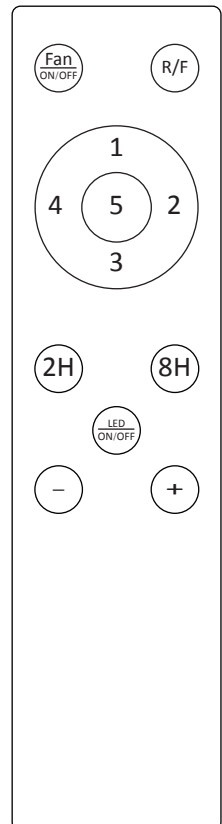

## CLEANING AND MAINTENANCE

- Before cleaning, turn off the appliance, cut off the power supply from the electrical outlet and wait for the appliance to cool down.
- To clean the appliance, use a soft cloth to wipe off any dust.
- Do not try to open the appliance without a licensed electrician.
- Improper installation is dangerous.
- Clean the appliance at least once a year.

### Maintenance

- Have the appliance repairs by a licensed electrician.
- This electric appliance is in accordance with the relevant safety requirements.
- Repair should be carried out by licensed electrician using the original spare parts, otherwise this might result in danger to the user.